

On Static vs. Dynamic Line Ratings in Renewable Energy Zones

Paul Simshauser^{*♦♥}
September 2023

Scaling-up Variable Renewable Energy will face critical bottlenecks vis-a-vis requisite transmission hosting capacity. Network developments must navigate the complexity of encroaching on private land, risk disturbing sites of cultural significance, compete with other environmental (i.e. biodiversity) objectives, and endure backlash from directly affected communities. Transmission is costly and post-pandemic supply-chain constraints are sending equipment costs higher. Given time and cost risks, existing transmission networks and successful augmentations need to function at their outer operating envelope. In this article, a Renewable Energy Zone (REZ) is examined by comparing static and real-time dynamic line ratings. Historically, static line ratings in the Queensland region of Australia's National Electricity Market reflected the still, hot conditions that characterised critical event maximum demand days. Widespread take-up rates of rooftop solar PV has shifted maximum (grid-supplied) demand to the late-afternoon when wind speeds are rising, which also provides thermal cooling to transmission lines. Optimisation modelling suggests a shift from static to dynamic line ratings for a reference 275kV radial REZ in Queensland can increase wind hosting capacity from ~1700MW to more than 2800MW with limited change in the asset base. Dynamically adjusting Frequency Control Ancillary Services further increases VRE hosting capacity.

Keywords: Renewable Energy Zones, Dynamic Line ratings, Frequency Control Ancillary Services, Variable Renewable Energy.

JEL Codes: D52, D53, G12, L94 and Q40.

* Centre for Applied Energy Economics & Policy Research, Griffith Business School, Griffith University.

♦ Energy Policy Research Group, University of Cambridge.

♥ Powerlink Queensland. The views expressed in this article are those of the author. The usual caveats apply.

1. Introduction

The task of decarbonizing our power systems requires the closure of existing coal plant and the entry of a vast array of Variable Renewable Energy (VRE, wind and solar PV) along with a suitable portfolio of storage and firming capacity (Peter and Wagner, 2021). By comparison to the thermal power stations for which they will replace, onshore VRE projects are typically smaller in size, exhibit lower capacity factors and span dramatically larger geographical footprints. The ability to secure the requisite permits for new VRE projects and associated augmentation of the transmission network is understandably becoming a critical issue in many jurisdictions. The fact that 48GW of higher-cost offshore wind projects (cf. onshore wind farms) had been developed across Great Britain, Europe and Asia by late-2021 provides the practical evidence that this is the case (Jansen *et al.*, 2022).

In Australia's National Electricity Market (NEM), the Queensland region has a vast landmass with high quality onshore VRE resources. Most of the 8000MW coal-fired generating fleet is slated for closure by the 2032 Olympic Games – being held in Queensland's capital city, Brisbane. Coal replacement requires ~25GW of utility-scale VRE. While the NEM has endured two decades of climate policy wars and exhibited a belated start to decarbonization efforts (Nelson, 2015, 2018; Dodd and Nelson, 2019, 2022; Rai and Nelson, 2020, 2021), VRE entry rates over the period 2016-2023 have been extraordinary. Across the NEM's five zones¹, 24.9GW of utility-scale wind, solar and batteries representing ~AUD²\$47 billion of investment commitments across 183 sites reached financial close (Simshauser and Gilmore, 2022). The NEM now has the 4th highest per capita level of wind and solar energy in the world.

Queensland's share of the renewable investment supercycle is ~30% or 7GW, meaning a further 18GW of VRE entry is required to replace the 8000MW coal fleet. The coal-fired generators are located at just six sites. By contrast, the existing 7GW is spread across 50+ sites and the incremental 18GW of VRE and associated firming capacity will no doubt span many more, along with transmission network augmentations.

Despite Queensland's vast land mass, site permitting is rising in complexity because VRE and transmission lines encroach on private land, risk disturbing sites of cultural significance, compete with other environmental (i.e. biodiversity) objectives, and above all – can experience considerable community backlash if not managed well. Much of Queensland's coastline is flanked by the Great Barrier Reef, which suggest development of offshore wind is likely to be problematic.

One policy initiative designed to lower costs and minimise the impact of VRE in Queensland is the concept of *Renewable Energy Zones* (REZ). REZs are planned for regional areas with high quality VRE resources but inadequate transmission infrastructure (Simshauser, 2021). In a practical sense, a REZ involves developing network transfer capacity 'at scale' to connect multiple VRE developments that would otherwise act, and connect, independently. REZs provide VRE hosting capacity and avoid needless and costly duplication of common infrastructure that would otherwise emerge. They also provide an opportunity to optimise the VRE mix and conduct *area wide planning* across landowner, cultural and heritage, environmental and biodiversity approvals and permitting – reducing transaction costs, development lags, and community impacts. In the classic case, a Queensland REZ involves a 'radial' augmentation extending from the (1700km long-) transmission backbone in order to connect multiple projects over time.

Building a fully subscribed REZ with multiple coincident VRE project commitments totalling 2000-3000MW could only occur by chance. The sheer complexity of achieving single VRE project financial close, let alone multiple projects simultaneously, means more likely 1-2 'anchor tenants' trigger initial REZ transmission investment commitment. Full subscription of the REZ would subsequently be achieved over the ensuing 5-10-year window (Simshauser, 2021).

¹ Queensland, New South Wales, Victoria, South Australia and Tasmania.

² At the time of writing AUD\$1 = US\$0.67 and £0.53. All financial are expressed in AUD unless otherwise denoted.

In Queensland, three REZs have commenced on a merchant basis – each being partially subscribed at the point of commitment. Connecting generators pay a share of the total connection burden and no more than a stand-alone counterfactual. Being merchant, the transmission utility carries any risk of REZ structural under-subscription. Regardless of whether regulated or merchant, the maximum network transfer capacity of the REZ and the optimal VRE capacity mix must be identified, and ideally achieved. Doing so means the number and costs of REZs may be minimised for a given level of VRE output.

Prior analysis of i). merchant REZ financing, and ii). REZ hosting capacity under conditions of static line ratings within an (implicitly) meshed network were dealt with in Simshauser (2021) and Simshauser, Billimoria and Rogers (2022). The purpose of this article is to extend this prior analysis by:

1. Identifying REZ power transfers with static, seasonal and real-time dynamic line ratings;
2. Highlighting the difference between REZ network transfer capacity and VRE hosting capacity; and
3. Identifying the effects of raising Frequency Control Ancillary Services enabled, which expands stability limits that otherwise constraint REZ transfer capacity.

Model results reveal surprisingly large gains from shifting to real-time dynamic line ratings. By necessity when derived, static ratings needed to err on the side of caution because generation fleets comprised coal- and gas-fired power stations to meet critical event summer peak demand periods – characterized by hot, still conditions during the middle of the day. REZs are designed to host wind and solar PV. The former do not commence production duties until wind speeds reach 3 meters per second (i.e. which has a coincident cooling effect on the thermal ratings of lines). Consequently, a shift from static to real-time dynamic line ratings can be expected to produce large gains in both network transfer capacity and VRE hosting capacity.

Furthermore, the network transfer capacity of a radial REZ will ultimately be limited by frequency stability considerations. Following the loss of a single circuit (e.g. lightning strike), generation output within the REZ is to be runback to levels consistent with the thermal rating of the remaining circuit. Increasing the Frequency Control Ancillary Services ‘raise’ can incrementally expand stability constraints, allowing greater post-contingent runback, and in turn, VRE hosting capacity.

This article is structured as follows. Section 2 reviews relevant literature. Models and data are introduced in Section 3. Results are presented in Section 4. Policy implications and concluding remarks follow.

2. Review of Literature

Literature relevant to the current analysis includes the change in policy emphasis (Sections 2.1 and 2.2) and distinguishing between locational signals, market design considerations, and network hosting capacity (Sections 2.3-2.6).

2.1 The 1990s reform era

The performance of regulated electricity utilities under the array of regulatory regimes is an empirical question (see Pierce, 1984; Hoecker, 1987; Kellow, 1996; Mountain and Littlechild, 2010; Simshauser, 2017 amongst many others). To generalize, from the 1970s through to the mid-1990s, a key challenge facing policymakers was how to best manage perverse incentives and adverse effects of electricity utilities overcapitalizing the power system (Joskow, 1987; Newbery and Pollitt, 1997; Booth, 2000). The origins of modern electricity market reforms can be traced back to Weiss (1973) although problems associated with the economic regulation of electricity utilities date at least as far back as Averch and Johnson (1962), Stigler and Friedland (1962), Stigler, 1971; Posner, 1974 and Peltzman, (1976).

The microeconomic reforms that followed commenced in Chile in the early 1980s (Pollitt, 2004) and were popularized by the England and Wales pool (Newbery, 2021). The reform template of restructuring vertical electricity monopolies, subsequent privatization and implementation of wholesale pool markets

effectively formed part of *the Washington Consensus*. Generation investments were decentralized and made contestable with returns dictated by volatile spot and forward electricity market prices (Finon, 2008). Transmission networks were unbundled and the economic regulation which governed network augmentation was, again to generalize, deliberately designed to slow the rate of investment to a 'least cost, just-in-time' framework. Given the state of the electricity sector in the 1990s these early reforms were necessary, and were met with considerable success (Newbery, 2021; Simshauser, 2021a; Joskow, 2022) albeit with a few high-profile exceptions such as California (Joskow, 2001; Borenstein et al., 2002).

2.2 The 2020 hybridisation era – market design vs hosting capacity

If the 1990s policy era could be described as '*restructuring and deregulation*', the 2020s policy era is best described as '*decarbonisation at pace*'. In policymaking, each policy objective is best achieved through a separate policy instrument. Decarbonisation does not fit neatly within existing energy market designs because the objective of the 1990s reforms was to maximise productive, allocative and dynamic efficiency. Existing market designs are characterised by forward price uncertainty (Joskow, 2022), imperfectly priced externalities (Newbery, 2016; Joskow, 2019; Pollitt, 2023), ever-present risks to security of supply given a reliability constraint (Joskow and Tirole, 2007; Wolak, 2022), and where existing capacity markets exist for this purpose, they may be distortionary for the task of decarbonisation (Mays, et al., 2019). The core issue for policymakers in competitive energy-only markets is that the rate of CO₂ emissions reductions delivered in the absence of an economy-wide CO₂ price may fall short of policy objectives.

This has led governments to incentivise VRE deployment through centrally auctioned Contracts-for-Differences or 'CfDs' (Billimoria and Simshauser, 2023). Government-initiated CfDs involve auctioning taxpayer- (or ratepayer-) wrapped, long-dated derivatives to underwrite new VRE capacity into electricity markets at rates which better match policy intent. To be clear, CfDs are effective in delivering VRE investments (Gohdes, et al., 2022, 2023; Simshauser et al., 2022).

This development, where government is effectively re-entering the electricity supply industry through the auctioning of CfDs, has been referred to as the 'hybridisation' of energy markets (Roques and Finon, 2017; Grubb and Newbery, 2018; Joskow, 2022; Keppler et al., 2022; Schittekatte and Battle, 2023; Billimoria & Simshauser, 2023; and Gohdes et al. 2023). Competition is maintained *for the market* with long-term investment decisions subject to a competitive auction process, and competition is maintained *within the market* through the dispatch process in the post-entry environment (Keppler et al., 2022).

A primary purpose of government coordination is the underwriting of long-term capital-intensive investment decisions from largely indeterminable spot price risks over medium-term investment horizons (Joskow, 2022). The security of revenue for banking purposes has long been considered critical for power project finance (Steffen, 2018; Simshauser and Gilmore, 2020, 2022; Gohdes et al., 2022; 2023; Nelson et al., 2013). VRE plant covered by investment-grade PPAs achieve comparatively favourable borrowing conditions and lower equity return requirements (Mills and Taylor, 1994; Kann, 2009; Grubb and Newbery, 2018; Steffen, 2018; Gohdes, et al., 2022, 2023; Nelson, et al., 2022).

The degree of energy market hybridisation required is an open question (cf. on-market transactions).³ In Australia's NEM, coal plant retirements have been well-telegraphed and this, of itself, seems to have stimulated significant demand for renewables via on-market PPAs from both corporate and utility sectors, and has produced record levels of VRE investment as Section 1 noted (Simshauser & Gilmore, 2022). Nonetheless, a certain level of 'CfD priming' by governments appears to have become a permanent fixture in energy markets. And in the case of Europe and Great Britain, CfD auctions have enhanced (short- to medium-run) consumer welfare given the energy price shocks that accompanied the 2022- war in Ukraine.

³ At a recent event in New South Wales by the state's auction coordinator (EnergyCo), two of the NEM's larger VRE investors suggested government-initiated CfDs are *nice to have but not necessary* given strong PPA demand from corporates and utilities.

However, what CfDs *do not solve* is structural inadequacies – the network capacity required to host large increases in VRE.

2.3 VRE locational decisions: nodal pricing vs. REZs

In jurisdictions such as Australia, Germany and Great Britain, there have been episodes in which CfDs have induced suboptimal locational decisions. This raises questions about the adequacy of locational signals in zonal markets. Engelhorn and Müsgens (2021) find better coordination of VRE investment locational decisions in Germany could have produced a 20% reduction in wind generation costs. In Great Britain, re-dispatch from constraints south of Scotland frequently run to as much as 10-30% of market volumes, with estimates of the ‘balancing mechanism uplift’ trending towards £4-6 billion per annum (Gowdy, 2022; see also Newbery 2023). In Australia, Simshauser & Gilmore (2022) find ~20% of entrants during the NEM’s VRE investment supercycle experienced adverse locational effects. VRE entry at-scale evidently produces spatial and temporal coordination problems (Aravena and Papavasiliou, 2017).

In Germany and Great Britain, inadequate locational signals, priority dispatch and the structure of revenues including deemed output (i.e. curtailment payments) led to an excess of VRE development on the wrong side of known network congestion – viz. in the northern regions of both markets where the quality of wind resources are high. The lack of locational consequence caused repeated investments within these locations, increasing consumer costs via re-dispatch, and payments to VRE generators for curtailed energy.

Regulatory authorities in Australia, Germany and Great Britain (amongst others) turned their attention to quintessential market design issues including Locational Marginal Prices which is thought to better coordinate investment location decision-making. Such proposals are intuitive. After all, zonal markets purposefully enlarge the inherent size of locational spot markets by ignoring (intra-regional) constraints and network congestion (Ruderer and Zöttl, 2018).

There should be no doubt the nodal market design envisaged by Schweppe et al., (1988) will outperform zonal markets by ~0.5-2.8% from a static dispatch efficiency perspective (Bjørndal and Jørnsten, 2001; van der Weijde and Hobbs, 2011; Holmberg et al., 2023). Market simulations of zone splitting or full nodal pricing of European and British markets within the literature consistently confirm this to be the case (Green, 2007; Leuthold et al., 2008; Oggioni and Smeers, 2012; Neuhoff et al., 2013; Oggioni et al., 2014; Abrell and Kunz, 2015; Aravena and Papavasiliou 2017).⁴ Modelling of Australia’s NEM analysing the existing multi-zonal design also suggests dispatch efficiencies of ~0.8-1.0%⁵ via switching to nodal pricing.

However as Professor Pollitt observes, these simulations find dispatch efficiencies by design. More locational prices can be taken to be more efficient than less, setting aside market power and investment considerations (Pollitt, 2023). The studies tend to present a narrow interpretation of gains as they ignore transaction costs of market redesign, assume away changes to investment risk premia, and fail to identify weather transmission *and* generation investment commitments would respond in a manner consistent with higher resolution of spot market signals.

Congestion rents are known to fall within the range of 10-30% of augmentation costs (Eicke et al., 2020) and Joskow (2022) observes nodal pricing *has not* been responsible for large transmission augmentations in US markets. Brown et al., (2020) analyse the change from zonal to nodal prices in Texas and found

⁴ Green found 1.3% in dispatch efficiencies. Interestingly, Oggioni et al (2014) found trivial gains when wind was not priority dispatched (and sizeable gains from nodal pricing when they were assumed to be priority dispatched). Leuthold et al. (2008), Neuhoff et al (2013), Abrell & Kunz (2015) and Aravena and Papavasiliou (2017) find gains in the range of 1-3%.

⁵ Modelling work undertaken by Roam Consulting in 2015 and NERA in 2020 on behalf of the Australian Energy Market Commission for ‘CoGaTI’ and predecessor projects.

weak- to no- evidence of improved locational decision-making by entrants. Gowdy (2022) similarly concluded nodal pricing does not create a *natural pathway* to a net zero power system. Observing the Texas market, he finds wind projects appear to respond to signals that are stronger than marginal prices alone, viz. wind resources, planning, permitting, and transmission network capacity. Additionally, there does not appear to be any evidence from US markets of increased investments in battery storage or flexible demand in response to rising constraints in nodal markets (Gowdy, 2022).

Indeed, Pollitt (2023) notes there are no serious cost-benefit analyses of changing to nodal pricing, their wider theoretical rationale in a world of VRE is not clear cut, and most importantly, the evidence on impact-in-use is surprisingly weak. Perhaps unsurprisingly, in Australia and Great Britain at least, proposals to shift from zonal and nodal markets have been deeply unpopular with energy industry participants, and renewable investors in particular (see Bashir, 2020 and Gowdy, 2022 on Australia and Great Britain, respectively).

To be clear, if a market reform was being originated, a nodal market design is optimal and presumably involves limited transaction costs compared to the counterfactual. But shifting a mature market from zonal to nodal is different. Transaction costs for spot markets are primarily associated with IT systems and internal process changes and will be sizeable⁶. But for forward electricity markets – which in Australia trade at 5x physical – it is akin to shifting traffic from left hand side driving (UK) to right hand side driving (USA), since all existing contracts (including PPAs and CfDs) are very likely to become frustrated because they reference the zonal price for settlement.

The nature of the ‘locational investment commitment problem’, which is thought to be significant in zonal energy markets, needs to be carefully untangled because three variables are at risk of being conflated, viz. i). inadequate contract risk allocation, ii). inadequate locational signals, and iii). inadequate network hosting capacity. To summarise the following, steps can be taken within zonal markets to improve investment locational signal which stop short of a complete redesign.

2.4 Inadequate contract risk allocation

When network congestion occurred in the northern regions of Germany and Great Britain where wind generation is prominent, constrained VRE generators were paid to curtail, and were therefore paid for *deemed output* (i.e. deemed output = actual energy + curtailed energy) through priority dispatch and CfDs, respectively. Consumers in Germany and Great Britain thus paid for both the cost of re-dispatch (i.e. higher cost generation located in the south) *and* the cost of wind generation constrained-off in the north. VRE investors in Germany and Great Britain were essentially shielded from network congestion and poor locational investment decisions. Perhaps unsurprisingly, both markets experienced repeated investments on the wrong side of known network constraints.

By contrast, the structure of CfDs and PPAs in Australia’s NEM default to *actual output*. This means that when VRE projects face network congestion, shareholders (not customers) bear the burden of curtailment (via reduced revenues). Consequently, poor locational decision-making by a VRE generator does not harm consumer welfare but rather, serves as a *warning to other VRE investors* not to invest in the area – with project banks becoming somewhat of an *enforcer* through their due diligence processes and lending practices.

Newbery (2023) revisits CfD design, noting fixed (and subsidised) strike prices guide location and dispatch decisions (cf. market prices). In Great Britain, VRE generators are normally paid this strike price even when constrained off (i.e. paid for deemed output). He finds designs need to incentivise efficient generator

⁶ Recent experience in Australia of the shift from 30 to 5-minute settlement involved upfront IT costs of ~\$1 billion across generators, retailers and network businesses. Recent studies suggest ~\$150m in dispatch inefficiencies, which tends to suggest a payback of 6-7 years for upfront IT costs.

offer pricing and dispatch, and any subsidy should underwrite capacity (subsidy per MW). Nelson et al. (2022) arrive at a parallel conclusion for Australian CfDs, suggesting the certificate form the commodity contracted with a zero price floor.

The basis of auctioning deemed output CfDs is (presumably) premised on reducing investor risk and the cost of capital for VRE projects. But as Gohdes et al. (2022, 2023) illustrate, renewable projects in Australia's NEM exhibit very low costs of capital despite facing the full financial consequence of network congestion. This tends to suggest 'deemed output' CfDs awarded to VRE entrants in any market should be queried as a market convention (and similarly regarding 'priority dispatch'). There may be sound reasons why a counterparty may choose to offer a deemed output PPA or CfD. But it should not form the default because it *detunes* VRE investors from locational risk.

2.5 Inadequate resolution of locational spot price signals

In Germany and Great Britain, generator offers are submitted with initial day-ahead dispatch scheduling occurring in a copper plate system before re-dispatch occurs in real-time. A single zonal price with no reflection of the transmission system eliminates locational signals. A first step might be zone splitting (e.g. north and south) which involves smaller transaction costs and less disruption than a nodal redesign. Well-designed (multi-) zonal markets should reflect transmission scarcities in a proximate way (Bjørndal and Jørnsten, 2008; Grimm *et al.*, 2016). An alternate or coincident step towards higher resolution locational signals within a (multi-) zonal market setting arises via ascribing Marginal Loss Factors to each generator (and load) connection point which as an aside, rarely exists in nodal markets.

Australia's NEM ascribes a Marginal Loss Factor or 'MLF' to each bulk supply point as a fixed annual coefficient, based on forecast *marginal transmission losses*, *ex ante*. Revision of MLFs occurs annually. Eicke et al., (2020) note despite its (multi-) zonal design, locational signals in Australia's NEM are amongst the strongest of 12 of the worlds' major electricity markets when the multi-zonal spot prices *and* the ~1400 site-specific MLF multipliers are accounted for (i.e. Revenue = Zonal Spot Price x site MLF x MWh Produced).

MLFs provide an acute locational signal for both dispatch purposes and investment decision-making – noting the market convention in the NEM is to write PPAs and CfDs at the regional reference node (i.e. where the MLF is deemed to be 1.0). This means that congestion risks (Section 2.4) and deteriorating MLF risk sit with VRE investors, not customers.

By way of example, generator MLFs at bulk supply points in North Queensland in 2016 prior to solar PV entry were typically ~1.0. By 2020 following a solar excess entry result (nb relative to local demand), MLFs in the post-entry environment fell to 0.85 – 0.90, meaning the zonal prices earned by these plants were universally adjusted downwards by 10-15% in each dispatch interval.⁷ Conversely, large-scale entry of solar PV plants in Southern Queensland in the pre- and post-entry environment remained at ~0.98. MLF coefficients send strong locational signals to emerging VRE investors within the NEM's zonal market setting. And to be sure, ultimately, post-entry changes to MLFs are no less *forecastable* than nodal prices.

2.6 Inadequate network hosting capacity

Dispatch efficiency is important. But the challenge facing the energy transition is the inadequacy of network transfer capacity and VRE hosting capacity, and driving VRE generation investments to the right places. And as Pollitt (2023) explains, it is not obvious that large numbers of nodal prices and associated

⁷ Specifically, solar plants at Barcaldine, Clare, Claremont, Daydream, Hamilton, Haughton, Hayman, Lilyvale, Ross River, Rugby Run and Whitsunday located in Central & North Queensland all had 2020 (i.e. post-entry) MLFs between 0.84 and 0.87. The same MLFs in 2016 (i.e. pre-entry) were around or above 1.00, but in the post-entry environment a localised collapse of loss factors reflected the impact of excess entry in the area. There have been similar loss factor experiences in regions like Alberta (AESO, 2020) which point to the global relevance the network co-ordination problem under the energy transition.

transaction costs with implementation is necessary to achieve the requisite transmission network capacity and locational signals.

This is where the importance of Renewable Energy Zones comes in. By way of simple example, in Texas the most important lead indicator of wind generation developments has been *anticipatory strategic network investments* that created additional network hosting capacity – in the west and northwest of Texas, where good wind resources are located (Gowdy, 2022). And conversely, the best indicator of stalled investment in wind generation has been points of rising network congestion – until the next round of transmission network augmentation occurred.

Numerous studies show transmission planners that guide market decisions on optimal locations given prevailing network hosting capacity can materially enhance welfare (Sauma and Oren, 2006; Tor, Guven and Shahidehpour, 2008; van der Weijde and Hobbs, 2012; Munoz et al., 2015; Alayo et al., 2017; Munoz et al., 2017; Ambrosius et al., 2019; Wagner, 2019). By definition, establishing new network capacity via a REZ sends an acute signal regarding optimal location of generation, noting investment commitment decisions are driven by *ex-ante* expectations of forward prices and locational signals, not *ex-post* outcomes (Hadush et al., 2011; Eicke et al., 2020).

REZs are anticipatory investments that deliberately oversize transmission capacity in the first instance, and consequently present a regulatory challenge vis-à-vis incentives. Yet in the Queensland case, REZs have thus far been undertaken outside the Regulatory Asset Base (i.e. as merchant investments with user charges levied on connecting generators) which largely eliminates adverse incentives.

As a final point, Pollitt (2023) notes it must surely be possible to improve dispatch efficiency without the wealth transfers which accompany a major market design. Australia's multi-zonal dispatch algorithm comprises a representation of nodal constraints, and generator offers are adjusted by locational Marginal Loss Factors. Consequently, the NEM's five zonal prices reflect least cost offers whilst representing the transmission system. To be clear, dispatch inefficiencies arising from the multi-zonal market exist, but the cost of inefficiencies are largely borne by investors (i.e. resource cost misallocation) rather than elevated consumer prices (i.e. there is no re-dispatch and no payment for curtailed or 'deemed' VRE output).

3. Models and data

Determining optimal VRE capacity within a REZ involves a sequence of models. The first is a conventional project finance (PF) model capable of determining plant costs (Section 3.1). Second is a dynamic REZ model to derive transmission line transfers (MVA) for each trading interval given ambient weather and power system transfer limits (Section 3.2). Finally is the VRE capacity optimisation model, which has an objective function of maximising renewable energy output subject to set levels of VRE congestion given transmission line ratings (Section 3.3).

3.1 VRE Plant Costs and the PF Model

The PF Model is an integrated multi-year project finance model tasked with simulating VRE projects. It produces a (generalised) levelized cost of electricity for given plant technologies, albeit at a level of detail beyond typical LCoE calculations because structured project finance and taxation variables are accommodated and co-optimised within the model. Critical inputs are listed Table 1 with the LHS panel outlining plant engineering parameters, and the RHS panel covering project finance variables. Project financing is assumed to be split into two tranches, a 5-year Bullet (Term Loan 'B') and an Amortising (Term Loan 'A') facility. All parameters are consistent with those in Gohdes et al. (2022, 2023) albeit updated to reflect recent observed market data.

Table 1 - PF Model Inputs (Engineering and Project Finance)

Variable Renewable Energy		Wind	Solar	Renewable Project Finance		
Project Capacity	(MW)	500	200	Debt Sizing Constraints		
Overnight Capital Cost	(\$/kW)	2,600	1,500	- DSCR	(times)	1.25
Annual Capacity Factor	(%)	35.0%	26.4%	- Gearing Limit	(%)	75.0
Expected Curtailment	(ppt)	1.0%	1.0%	- Default	(times)	1.05
Auxillary Load	(%)	1.0%	0.5%	Project Finance Facilities - Tenor		
Transmission Losses	(MLF)	0.980	0.960	- Term Loan B (Bullet)	(Yrs)	5
Fixed O&M	(\$/MW/a)	20,000	20,000	- Term Loan A (Amortising)	(Yrs)	7
Variable O&M	(\$/MWh)	5.00	0.00	- Notional amortisation	(Yrs)	25
Ancillary Services Costs	(% Rev)	-5.0%	-5.0%	Project Finance Facilities - Pricing		
				- Term Loan B Swap	(%)	4.03
				- Term Loan B Spread	(bps)	180
				- Term Loan A Swap	(%)	4.14
				- Term Loan A Spread	(bps)	200
				- Refinancing Rate	(%)	5.03
				Expected Equity Returns	(%)	8.0

Source: Simshauser & Gilmore (2022); Gohdes et al. (2023), Reserve Bank of Australia.

Full model logic is set out in Appendix I.

3.2 Dynamic REZ Model

The Dynamic REZ model comprises static, seasonal and dynamic line ratings for a double circuit 275kV radial REZ. All relevant variables have been derived from Powerlink (Queensland's transmission network utility) in line with the 'Transmission Line Ratings Specification (2020)' and 'TNSP Operational Line Ratings (2009)' documents, both of which are publicly available and the latter being a NEM-wide reference developed by Australia's TNSPs.⁸

- **REZ with Static Line Ratings**

In line with prior research (viz. Simshauser, 2021; Simshauser et al., 2022), static line ratings have been fixed such that $(REZ_{t=Sum}^{Stat}) = 1500MW$. Continuity of this assumption provides a consistent base case.

- **REZ with Seasonal Line Ratings**

Critical variables for determining seasonal and dynamic transfer limits centre on the conductor type and allowable operating temperature under 'normal' and 'emergency' conditions. For the case at hand, a reference twin-sulphur conductor is assumed with normal and emergency operating temperatures of 75° and 90° C, respectively. This in turn leads to seasonal line ratings (50-200km from coast) as follows:

Table 2 - Seasonal Line Ratings (Amps)

	Normal Rating (Amps)	Emergency Rating (Amps)
Summer	1734	2582
Mild Seasons	1981	2774
Winter	2162	2922

FCAS raise = 750MW

Source: Powerlink.

⁸ Available at www.powerlink.com.au

Seasonal power transfer capacity of a double circuit 275kV Renewable Energy Zone in the peak summer period ($REZ_{t=Sum}^S$) can be defined as follows:

$$REZ_{t=Sum}^S = \text{Min}[(2 \cdot \sqrt{3} \cdot 0.275 \cdot NR_{t=Sum}^S \cdot 0.93), (\sqrt{3} \cdot 0.275 \cdot ER_{t=Sum}^S \cdot 0.93 + FCAS^S), \theta_{Sum}^S] \quad | \quad REZ_{t=Sum}^S = \text{Min}(1536 \text{ MW}, 1893 \text{ MW}, 2863 \text{ MW}) \quad (1)$$

In Eq.(1), the first term identifies static seasonal (superscript 'S') thermal transfer capacity for each conductor for each of two circuits ($2 \times \sqrt{3} \times 0.275 \times \text{Current}$) operating at *Normal Rating* $NR_{t=Sum}^S$ during summer (subscript t=Sum) and converted to MW assuming a power factor of 0.93. The second term in Eq.(1) repeats this process for a single circuit operating at its *Emergency Rating* $ER_{t=Sum}^S$ with a runback enabled at the $FCAS^S$ level. The third term θ_{Sum}^S is an exogenous constraint and can be thought of as a downstream fixed capacity limit (e.g. capacity of the substation equipment).

On FCAS raise quantities, Australia's NEM enables Frequency Control Ancillary Services duties in a largely dynamic process driven by the single largest credible contingent event. Under normal system conditions this is typically the largest spinning generation unit (Kogan Creek) which is rated at ~750MW. Consequently 750MW of real-time spinning reserves over 6 second, 60-second and 5-minute periods are enabled by the market operator. If the unit is offline for maintenance (or operating at partial load) the quantity of FCAS enabled reduces to the next largest unit (typically 720MW in the adjacent region of New South Wales). Subsequent modelling assumes FCAS is 750MW unless otherwise specified.

To illustrate why the first two terms in Eq.(1) exist in a real-time power system setting, consider Figure 1, which illustrates the credible envelope of REZ transfer capacity under two distinct operating conditions.

Figure 1 - Double circuit 275kV credible transfer capacity – summer seasonal line rating

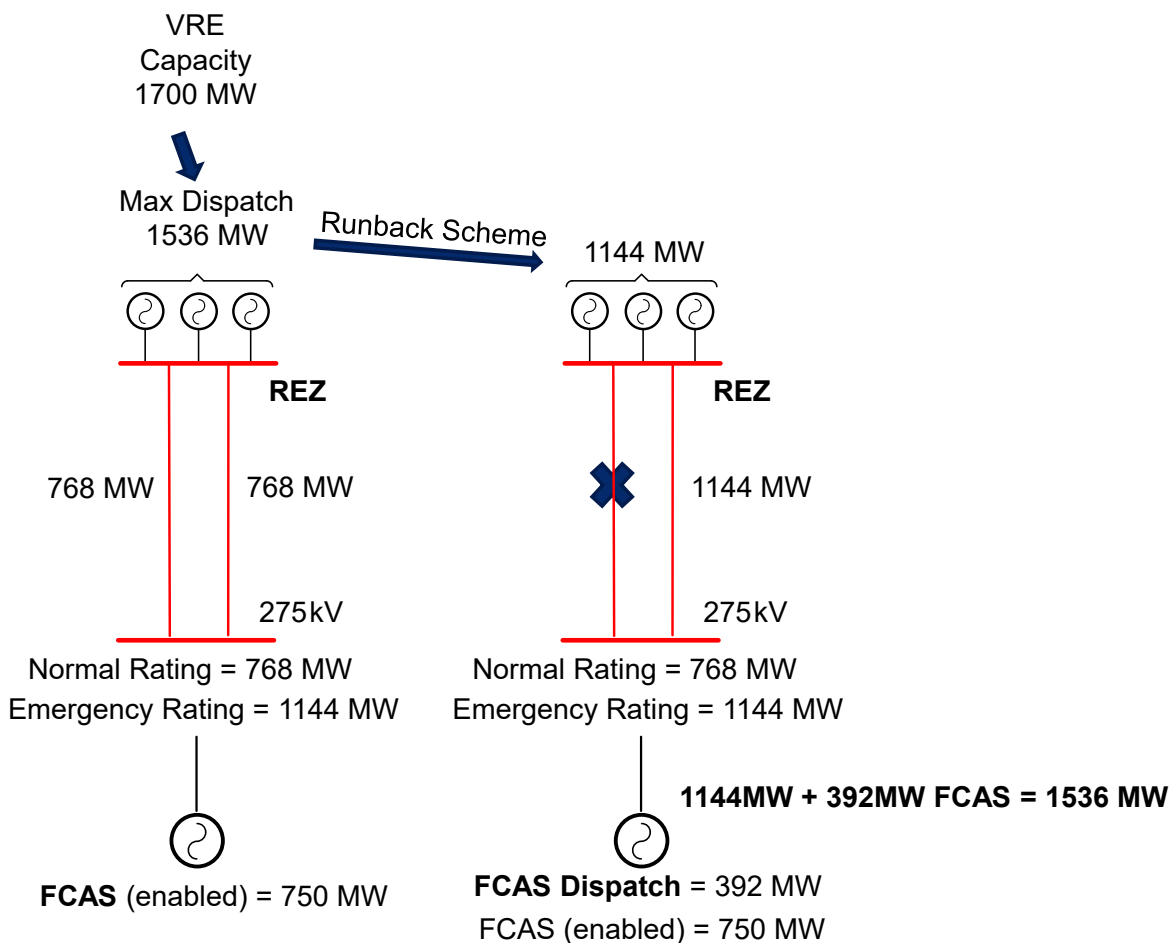

The first point to note from Fig.1 is that there is 1700MW of VRE capacity installed. The LHS illustrates that maximum VRE dispatch is constrained to 1536MW. With both 275kV circuits in-service, maximum dispatch is bound by *normal line ratings*. That is, each conductor is operating at its *normal summer rating* of 1734 Amps, with each circuit at 768MW (totalling 1536MW).

The RHS illustrates how the system adjusts following the loss of a circuit. Note the 1700MW VRE capacity, limited to 1536MW maximum dispatch, is constrained to 1144MW in real-time under a 'runback scheme' (post-contingent protection scheme). This new production constraint is set by the *emergency summer rating* of each conductor at 2582 Amps, with the remaining circuit in-service at 1144MW.

The system operator's FCAS suite of 750MW enabled is called upon in real-time for 392MW of power to rebalance the system (i.e. 1144 MW + 392 MW FCAS = pre-contingent output of 1536 MW = 2 x 768MW).

If a circuit outage fails to auto-reclose within 5-10 seconds, the power system must be rebalanced to a secure state within 30 minutes. Specifically, after the loss of a single circuit, the remaining 275kV circuit is now operating at its *emergency summer rating* (Fig.1). The 1144MW dispatch from the remaining circuit now exceeds the 750MW FCAS raise suite and therefore becomes the next (and much larger) credible contingency. If a subsequent attempt to manually re-close the lost circuit fails (usually attempted at 15-minutes), dispatch across the remaining circuit will need to reduce the REZ output to the limit of the FCAS raise suite.

- **REZ hosting capacity with Dynamic Line Ratings**

In the pre-VRE era, Queensland's generating fleet was dominated by low-cost baseload coal plant and flexible gas turbines. From a power system planning perspective, optimal generating capacity for a given transmission connection was bound by (static) summer ratings illustrated in Fig.1 (LHS). Prior to VRE capacity, this represented sound practice. Queensland's tropical climate meant power system critical event maximum demand would occur during the early afternoon in summer (i.e. 1pm - 2pm) when ambient temperatures reached their maximums. For example, from 1pm-2pm ambient temperatures on the Western Downs (location of the modelled REZ) routinely reach 40⁰ Celsius with wind speeds simultaneously below 0.5 meters per second. Power system planners – determining the transfer capacity available to coal and gas-fired plant required to meet critical event maximum demand – would understandably rate transmission line capacity using conditions relevant at that time.

In the VRE-era, system dynamics are different. On the demand-side, Queensland has the highest household take-up rate of rooftop solar PV in the world. 44% of detached homes have installed a PV unit with average capacity of 6.8 kW (Simshauser, 2022). The total rooftop PV is ~5400MW against aggregate maximum final demand of ~11,600MW (and grid-supplied maximum demand of ~10,200MW). The difference between aggregate final demand and power system peak demand is nuanced, but important. Aggregate final demand of 11,600MW still occurs between 1pm-2pm – but more than 2500MW is satisfied *behind-the-meter*. Grid-supplied power system maximum demand of 10,200MW has been shifted to late-afternoon, at ~5pm (Simshauser, 2022).

Furthermore, on the supply-side the typical anchor tenant(s) of REZs are large wind farms. This has considerable relevance to transmission line ratings. The diurnal pattern of wind in Queensland tends to 'dip' during the middle of the day as Fig.2 illustrates, with maximum wind production occurring outside periods of highest ambient temperatures. Moreover, wind turbines operate when wind speeds exceed 3 meters per second. Subject to the direction and angle, elevated wind speeds have a cooling effect vis-à-vis thermal line ratings. Collectively, cooler temperatures and elevated wind speeds mean the credible hosting capacity of wind generation within a REZ with dynamic line ratings may be substantially higher than static ratings suggest.

Figure 2 - Average summer dispatch: wind vs solar (Western Downs 2017-2021)

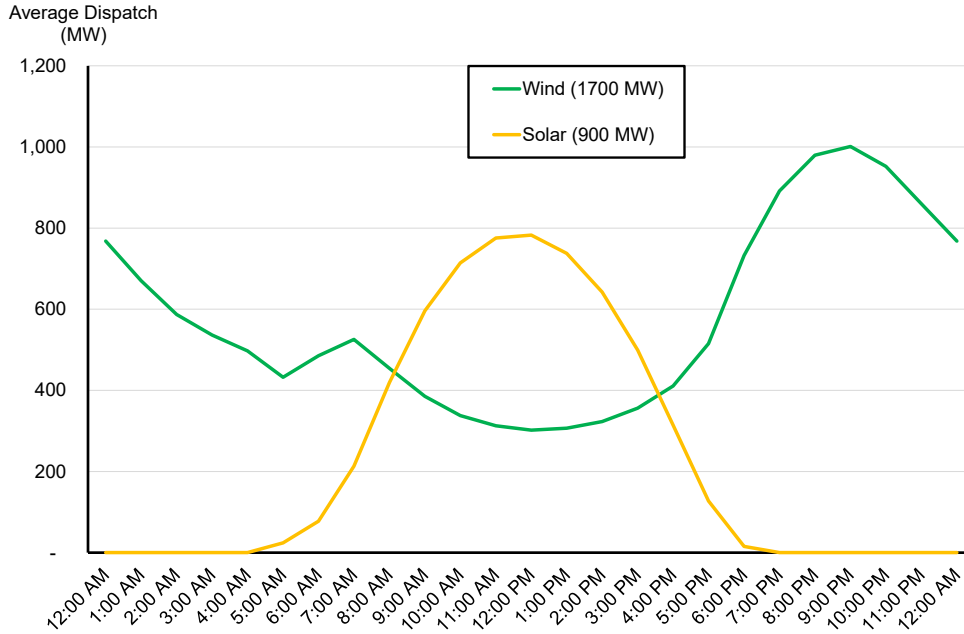

Eq.(2) sets out the form of REZ hosting capacity with dynamic line ratings. The RHS of Eq.(2) identifies the array of variables driving dynamic line ratings including Conductor Type CT , emergency temperature rating T_{max} , number of conductors C_n , wind speed W_s , wind angle to the conductor W_{ang} , ambient temperature T_{am} , solar angle S_{ang} , solar absorption coefficient A and the emissivity of the conductor surface over time E .

$$REZ_{t=Sum}^{Dyn} = \left(\text{Min} \left[\begin{array}{l} (2 \cdot \sqrt{3} \cdot 0.275 \cdot NR_t^{Dyn}) \cdot 0.93, \\ \{(\sqrt{3} \cdot 0.275 \cdot ER_t^{Dyn}) \cdot 0.93 + FCAS\} \\ \theta_{Sum}^{Stat}, \end{array} \right] \middle| \begin{array}{l} NR_t^{Dyn}, ER_t^{Dyn} = F(CT, T_{max}, C_n, W_s, W_{ang}, T_{am}, S_{ang}, A, E), \\ \forall t \in T \end{array} \right) \quad (2)$$

Recall with seasonal line ratings (Eq.1, Fig.1) that hosting capacity was limited by the first term, i.e. *normal summer rating* of 2 x 275kV circuits at a total 1536MW. With dynamic line ratings, the binding constraint during normal operations (and windy conditions) is more likely to be the Emergency Rating of conductors, ER_t^{Dyn} plus FCAS raise enabled. The intuition here abstracts to the ‘whole of transmission system’ level. This is illustrated in Fig.3 with wind speeds assumed to be $\gg 3$ meters per second, and ambient temperature of 26.9⁰ Celsius at 1am in the morning.

Figure 3 - Double circuit 275kV transfer capacity: dynamic line ratings

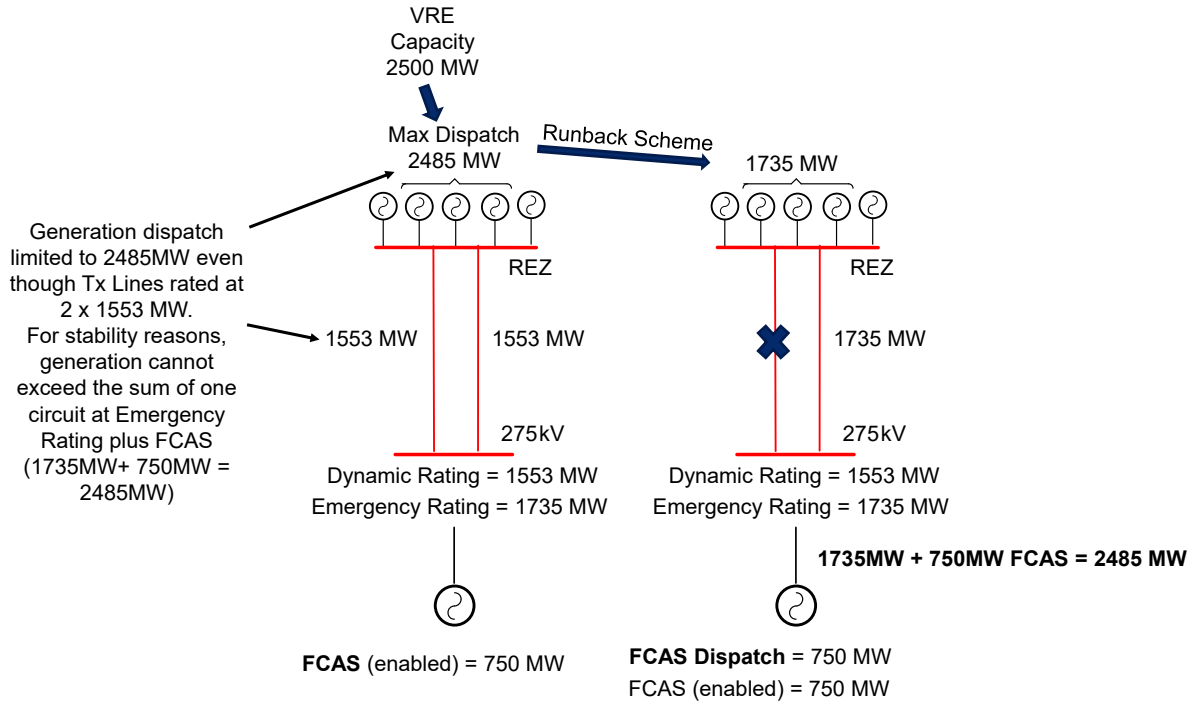

3.3 VRE Capacity Optimisation Model

The VRE Capacity Optimization Model seeks to maximise total production (or profit if specified) subject to an array of constraints. This includes available hosting capacity and transfer limits set by the Dynamic REZ Model (Section 3.2).

Let $re \in RE$ be the set of wind and solar projects connecting to the REZ, each with installed capacity $K_{re,t}^{re}$ and proportion of plant availability $\beta_{re,t}^{re}$. Let $t \in T$ be the set of dispatch intervals and $G_{re,t}^{re}$ be output of generator re . At this point, the objective function is a relatively straight-forward one:

$$OBJ_{GEN} = Max (\sum_{t \in T} \sum_{re \in RE} G_{re,t}^{re}) \quad (3)$$

S.T.

$$G_{re,t}^{re} \leq K_{re,t}^{re} \beta_{re,t}^{re} \quad \forall re \in RE, t \in T \quad (4)$$

$$\sum_{re \in RE} G_{re,t}^{re} \leq N_t^{tx} \quad \forall t \in T \quad (5)$$

$$\sum_{re \in RE} G_{re,t}^{re} \geq (1 - \delta_{re}^{re}) \cdot e(G_{re,t}^{re}) \quad (6)$$

Eq.(4) limits generation to available capacity $K_{re,t}^{re} \beta_{re,t}^{re}$ while Eq.(5) constrains total generation in each dispatch interval $t \in T$ to the static, seasonal or dynamic line rating capacity of REZ, N_t^{tx} in accordance with Eq.(1). Eq.(6) ensures the average congestion (δ_{re}^{re}) impacting expected output $e(G_{re,t}^{re})$ of VRE plant does not exceed tolerable banking limits (noting economic curtailment from negative prices is a separate issue). Real-time weather data for the solar and wind projects were derived from Gilmore et al. (2022) which in turn has been derived from MERRA2.

4. Model Results

In the present analysis, benchmark VRE projects are modelled at 500MW and 200MW for wind and solar without loss of generality. For REZ optimization, projects are scaled on a linear basis.

4.1 PF Model Results – wind and solar PV unit costs

PF Model results for wind and solar (\$/MWh) are outlined in Fig.4. Entry costs for wind (\$71) and solar PV (\$66) have increased by ~\$20/MWh⁹ or 35-40% over the past three years following adverse supply-chain effects of the Covid-19 pandemic and the war in Ukraine.

Figure 4 - Unit cost of wind and solar PV projects on the Western Downs

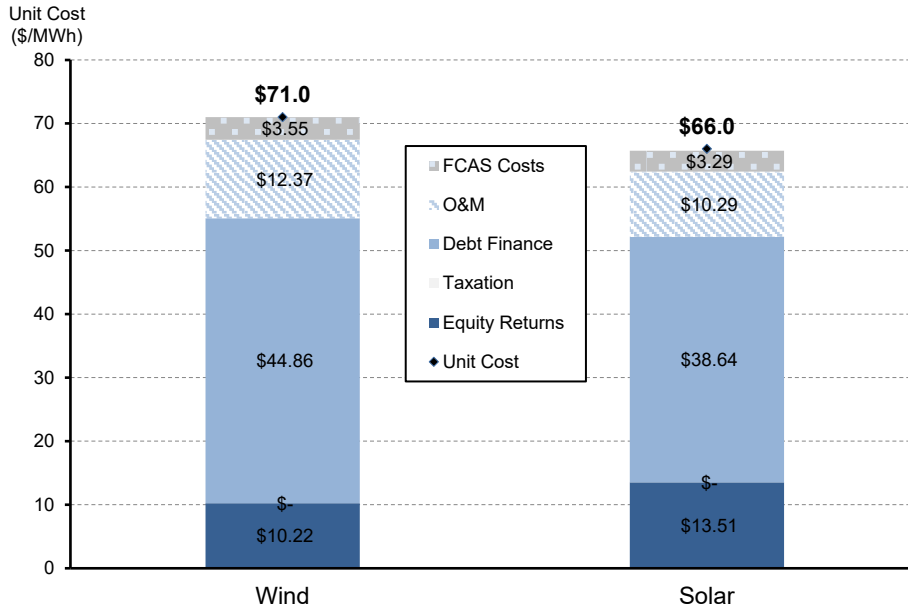

4.2 Dynamic REZ Model Results – static, seasonal and dynamic line ratings

A comparison of REZ transfer limits in Fig.1 and 3 imply a shift to real-time dynamic line ratings may lead to material increases in transfer and VRE hosting capacity. Model results are illustrated via the Fig.5 boxplot. The first entry highlights the static line rating used in Simshauser et al., (2022), at 1500MW. The second boxplot presents seasonal line ratings, with transmission hosting capacity lying within a tight range of 1536MW in summer, 1916MW in winter and 1756MW in mild seasons.

The third box plot shows the same 275kV asset assuming real-time weather feeds (monitoring lower spans) thus enabling the network energy management system to dynamically rate lines according to ambient conditions. The 95th percentile rises to 2084MW – an increase of 584MW. Note dynamic ratings cut both ways, in certain conditions ratings fall to 1312MW.

⁹ Of this \$20/MWh increase, capital equipment costs have contributed ~\$12/MWh and the cost of capital (i.e. rising interest rates) has contributed ~\$8MWh.

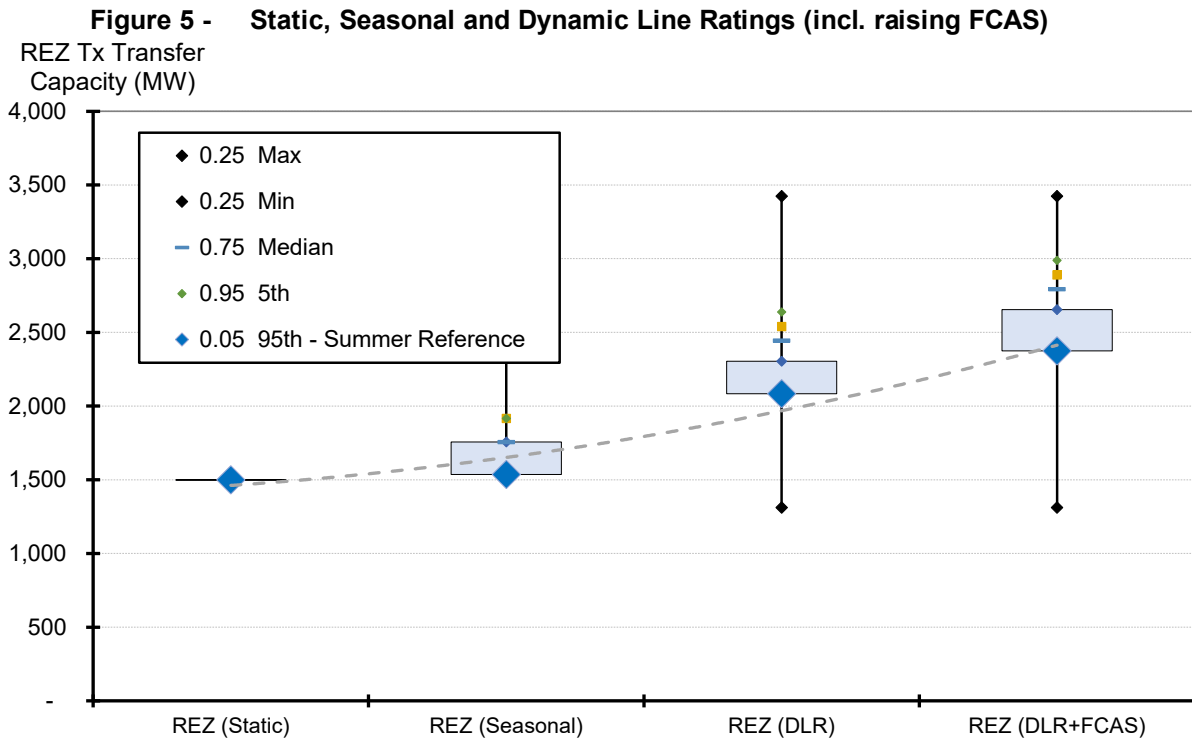

The final box plot in Fig.5 combines dynamic line ratings with an expanded FCAS suite, from 750MW to 1100MW. The intuition here relates to expanding stability limits. Recall from Fig.1 and 3, the binding constraint shifted from thermal limits to a stability limit, the latter being the sum of Emergency Ratings of a single circuit *plus* FCAS raise enabled. Consequently, if transmission line transfers = Emergency Rating + FCAS, then raising FCAS can potentially further raise transfer capacity (MW) – albeit noting other power system constraints will ultimately constrain transfers (e.g. substation bays or ability to provide system security for the non-credible loss of both REZ circuits). A statistical comparison of results is presented in Tab.3.

Table 3 - Distribution of static, seasonal and dynamic line ratings

	REZ (Static)	REZ (Seasonal)	REZ (Dynamic)	REZ (DLR +FCAS)	Change (MW)
Max	1,500.0	1,916	3,423	3,423	1,923
5th Perc.	1,500.0	1,916	2,639	2,989	1,489
75th Perc.	1,500.0	1,756	2,305	2,655	1,155
Median	1,500.0	1,756	2,444	2,794	1,294
25th Perc.	1,500.0	1,916	2,539	2,889	1,389
95th Perc	1,500.0	1,536	2,084	2,375	875
Min	1,500.0	1,536	1,312	1,312	-188

4.3 VRE Capacity Optimisation Model Results

The primary task of the Capacity Optimisation Model is to identify the portfolio of wind and solar PV plant which maximises VRE output¹⁰. The Model prescribes certain constraints, including that the Annual Capacity Factor (ACF) of wind (35%) and solar PV (26.5%) must not face more than 1 percentage point (ppt) congestion within the REZ, on average, over the five-year window.¹¹ This latter constraint is applied in the context of ‘project bankability’.

¹⁰ The model also derives profit if specified.

¹¹ In a practical sense, this may mean less than 1 ppt congestion in a high-wind year, and above 1 ppt in a low-wind year – but in aggregate cannot exceed 1 ppt on average over the five-year window. The same is applied to solar PV.

It is both inefficient and impractical to size VRE capacity within a REZ with no network congestion (as Fig.7-8 subsequently reveal). Conversely, there is a tolerance limit to network congestion by equity investors and project banks. This tolerance will change (increase) over time – whether 1ppt network congestion is a suitable proxy is an empirical matter but for the purposes of the present analysis, forms the prevailing benchmark. Optimisation model results for wind and solar PV capacity is illustrated in Fig.6.

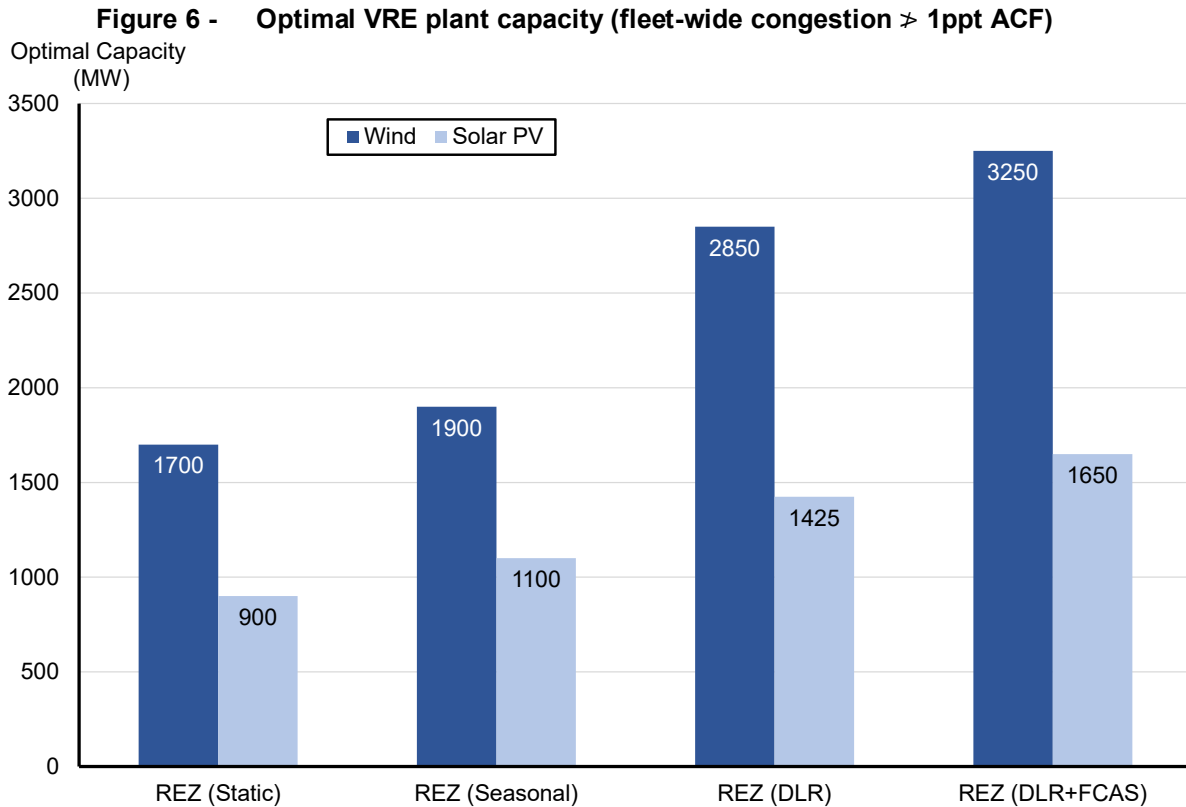

With REZ (Static) results, transfer capacity limits are fixed at 1500MW throughout the year and the Model finds optimal VRE hosting capacity to be 1700MW of wind and 900MW of solar PV (2600MW in total). Prima facie, given a binding constraint of not more than 1ppt lost ACF production, this may appear implausible but the intuition behind this result has two dimensions:

1. Queensland wind and solar PV output are complementary resources (see Fig.2). At the margins (i.e. high wind *and* high solar irradiation) the two technologies compete for scarce REZ transfer capacity. However, quantitative results suggest this occurs ~680 hours per annum or 7.8% of yearly dispatch intervals (see Fig.7).
2. Wind generation output is stochastic over 24 hours and reaches full productive capacity only periodically. The 1700 MW of wind will only exceed 90% of nameplate generating capacity for just 120 hours per annum, on average (see Fig.7). Consequently, optimal wind capacity should always exceed transmission line capacity. And as REZ transfer capacity rises through seasonal or dynamic line ratings, so too, will optimal wind capacity within a REZ.

Figure 7 - Wind Output and VRE portfolio output (ranked) vs Static Line Rating

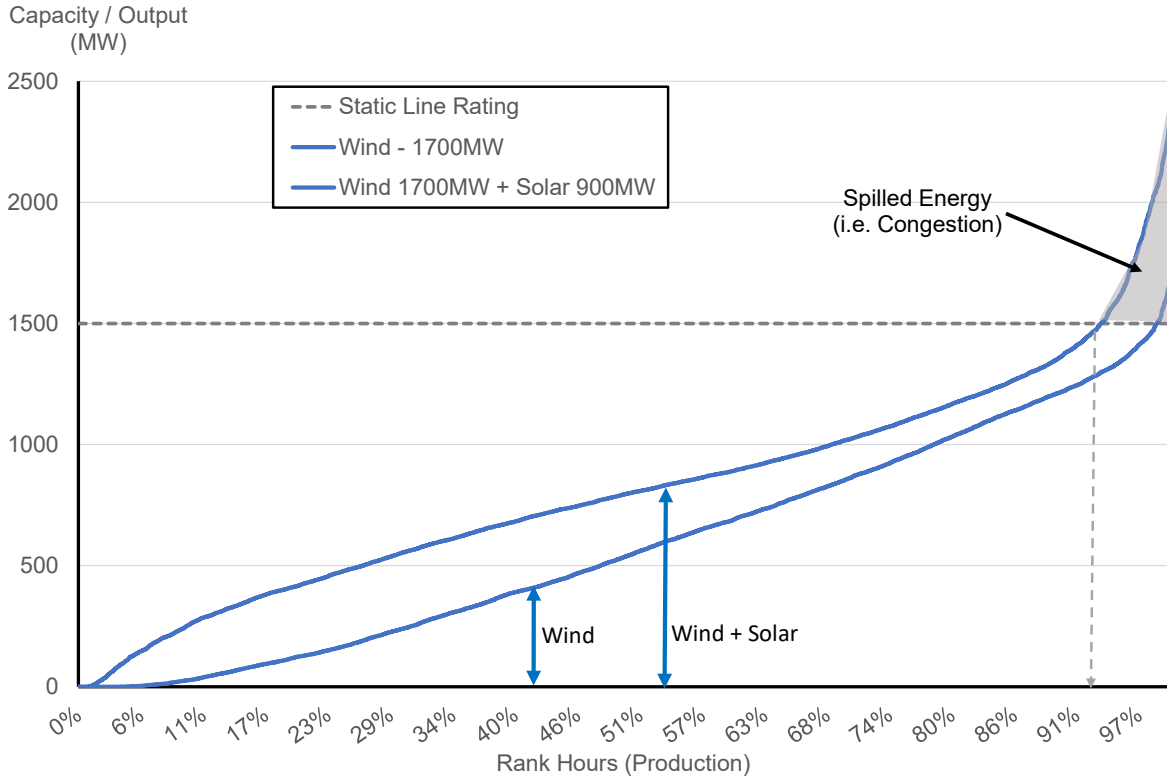

In Fig.6, shifting from REZ (Static) to REZ (Seasonal) ratings produces a gain of ~200MW for wind and solar PV. More interesting are gains extracted from moving to dynamic line ratings REZ (DLR). Compared to REZ (Static), REZ (DLR) in Fig.6 points to a near-doubling of wind capacity to 2850MW (+1550MW) and a 500+MW increase in solar. The intuition behind this result relates to conditions underpinning DLR – note from Tab.4 the correlation between DLR and Wind output is +0.44, whereas solar PV is -0.09.

Table 4 - Correlation of model variables

	SLR	DLR	Wind	Solar	VRE Portfolio	Ambient Temp
SLR*	1.00					
DLR	0.12	1.00				
Wind	0.04	0.44	1.00			
Solar	-0.03	-0.09	-0.28	1.00		
VRE Portfolio	0.02	0.36	0.77	0.39	1.00	
Ambient Temp	-0.57	-0.08	-0.14	0.42	0.15	1.00

*SLR = Seasonal Line Ratings

Fig.8 provides a more granular representation using 2020-year data (and includes Fig.7 data for ease of comparison). The first point to note from Fig.8 is the material step-up in transfer capacity associated with DLR (cf. static). Additionally is the apparent relationship between DLRs (grey line series) and ranked wind production (blue line series), both of which are upward sloping. If the same chart was produced comparing solar PV output and DLR, it would illustrate a step-up in hosting capacity but relative to ranked solar production would exhibit no obvious relationship, consistent with Tab.4 results.

Figure 8 - Wind Output and VRE portfolio output (ranked) vs Dynamic Line Ratings¹²

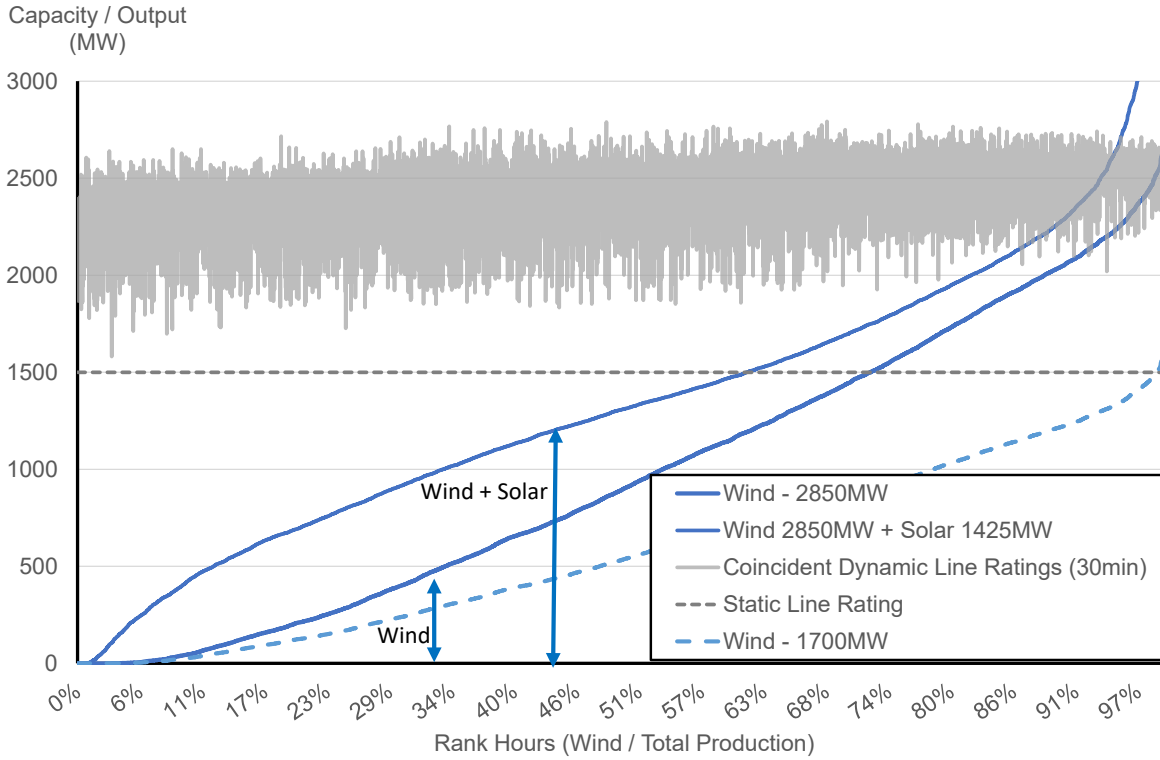
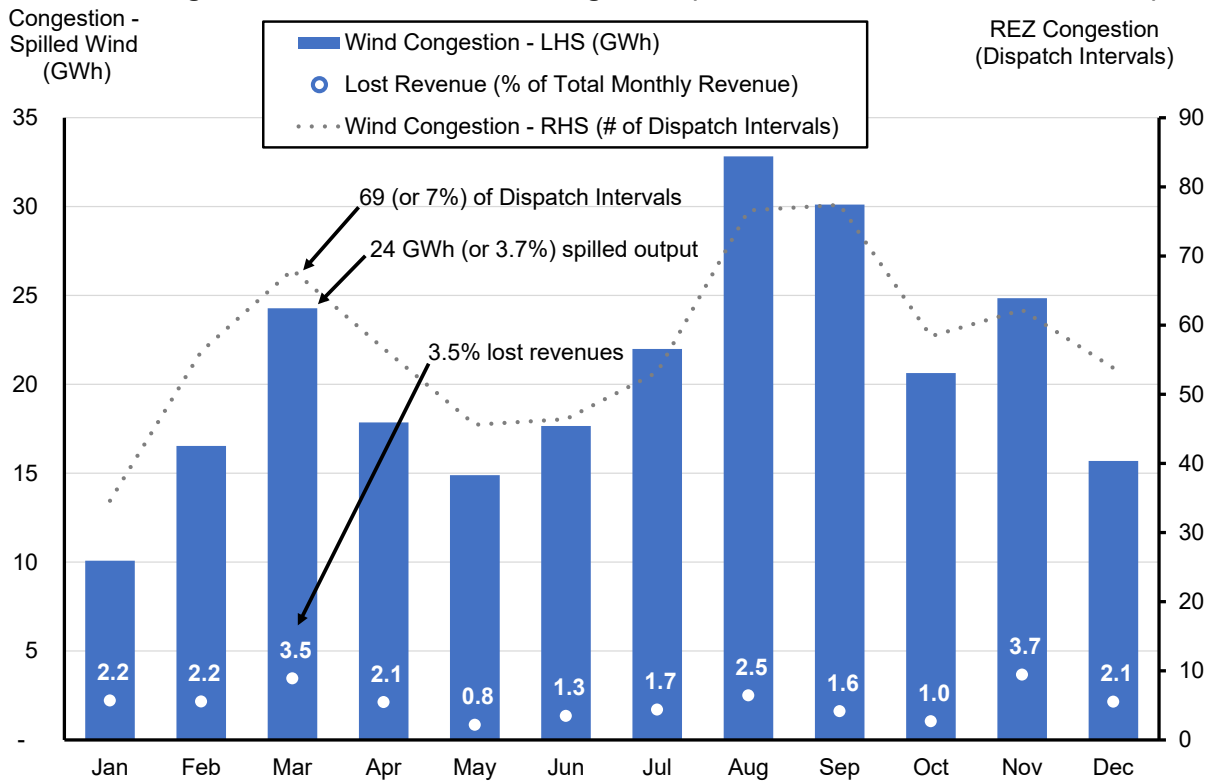

Fig.9 provides insights regarding the timing of congestion and lost (spot) revenues using the matching (5-year) history of 30-minute spot price data.

Figure 9 - Incidence of line congestion (DLR: 2850MW wind + 1425MW solar)



¹² Note the data used in this chart relates to the 2020 year and therefore may not reflect the extremities captured in the five-year results outlined in Fig.5.

4.4 The impact of dynamic FCAS

The final scenario outlined in Tab.3 and Fig.6 involved DLR combined with FCAS solved dynamically up to a maximum of 1100 MW (essentially replicating an 'n-2' FCAS suite on a post-contingent basis). This increases REZ transfer capacity by up to 350MW (Fig.5 and Tab.3). And as Fig.6 illustrates, the model finds VRE hosting capacity increases of 600 MW, comprising 400MW of wind and 200MW of solar. Importantly, such an increase arising from FCAS can be captured by any REZ facing similar constraints.

4.5 Network Congestion vs. Economic Curtailment

Thus far, the analysis compared potential VRE output with practical VRE output. The difference between potential and practical output is energy spilled arising from the limitations of REZ transmission transfer capacity, and, the deliberate overbuild of VRE capacity such that pro-rata-shared wind and solar fleet ACF losses \geq 1ppt (i.e. the 'bankability' constraint per Eq.6):

- Practical VRE Output = Potential VRE Output /less Network Congestion

Also relevant to investment decisions is the extent of economic curtailment – when it is not viable for an unconstrained generator to produce due to negative price events. That is:

- Economic VRE Output = Practical VRE Output /less Economic Curtailment.

Five years of historic spot price data (holding all else constant) has been included in the Optimisation Model to quantify economic output. Full results are presented in Tab.5.

Table 5 - Comparison of Capacity and Output by REZ scenario

	REZ (Static)	REZ (Seasonal)	REZ (Dynamic)	REZ (DLR +FCAS)	Change (MW)
Capacity (MW)					
Wind	1,700	1,900	2,850	3,250	1,550
Solar PV	900	1,100	1,425	1,650	750
Total	2,600	3,000	4,300	4,900	2,300
Potential Plant Output (GWh pa)					
Wind	5,100	5,800	8,600	9,900	4,800
Solar PV	2,100	2,500	3,300	3,800	1,700
Total	7,200	8,300	11,900	13,700	6,500
Practical Plant Output (GWh pa)					
Wind	5,000	5,600	8,400	9,600	4,600
Solar PV	2,000	2,500	3,200	3,600	1,600
Total	7,000	8,100	11,600	13,200	6,200
Economic Plant Output (GWh pa)					
Wind	4,900	5,500	8,200	9,400	4,500
Solar PV	1,900	2,300	3,000	3,400	1,500
Total	6,800	7,800	11,200	12,800	6,000

Tab.6 presents ACFs and Expected Profits (assuming a renewable certificate price of \$10/MWh). Results confirm optimal capacity for each of wind and solar has been derived by reaching the limit of the ACF \geq 1ppt constraint. In addition, note plant output is additionally impacted by negative price events (solar 1.6ppt ACF loss, wind 0.6% ACF loss). But both technologies clear their total average cost (i.e. including debt finance costs and normal returns to equity) in aggregate.

Table 6 - ACFs and Expected Profits

	REZ (Static)	REZ (Seasonal)	REZ (Dynamic)	REZ (DLR +FCAS)
Wind Annual Capacity Factor				
Potential ACF	34.6%	34.6%	34.6%	34.6%
<i>less Congestion</i>	-1.0%	-1.0%	-1.0%	-1.0%
<i>less Curtailment</i>	-0.6%	-0.6%	-0.6%	-0.6%
Economic ACF	33.0%	33.0%	33.0%	33.0%
Solar PV Annual Capacity Factor				
Potential ACF	26.4%	26.4%	26.4%	26.4%
<i>less Congestion</i>	-1.0%	-1.0%	-1.0%	-1.0%
<i>less Curtailment</i>	-1.6%	-1.6%	-1.6%	-1.6%
Economic ACF	23.8%	23.8%	23.8%	23.8%
Wind Profits				
Revenues	\$436,071	\$489,837	\$740,508	\$849,430
Costs	\$382,267	\$425,485	\$632,803	\$719,826
Profit	\$53,804	\$64,352	\$107,704	\$129,604
Solar PV Profits				
Revenues	\$155,730	\$191,418	\$257,555	\$301,832
Costs	\$142,398	\$173,272	\$222,408	\$256,834
Profit	\$13,332	\$18,146	\$35,146	\$44,998

Fig.10 contrasts the relative scale of energy produced, impacts of network congestion, and economic curtailment arising from negative price events.

Figure 10 - VRE energy produced (fleet-wide congestion \geq 1% ACF)

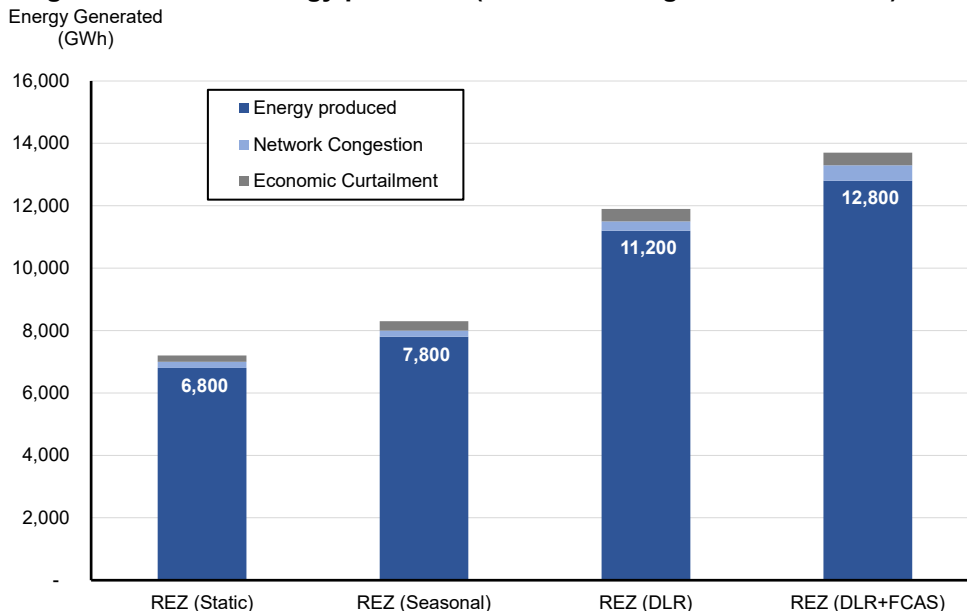

5. Policy implications and concluding remarks

The purpose of this article was to examine gains from dynamic line ratings in a radial REZ. Static line ratings in Queensland reflected circumstances triggered by critical event maximum demand days – hot and still conditions during the middle of the day. Shifting to renewable resources induces a different set of

circumstances. Rooftop solar PV reduces demand-side risk exposures by shifting grid-supplied peak demand to late-afternoon. And the changing plant mix – wind generation in particular – reduces supply-side risk exposures of line ratings since production occurs in windy conditions. Presumptions of ‘hot, still conditions’ no longer seem relevant, hence the motivation to investigate real-time transmission line ratings.

The suite of models illustrated a radial REZ comprising a double circuit 275kV transmission line with ~1500MW (static) transfer capacity could comfortably accommodate 1700MW of wind generation. A surprising amount of complementary solar PV capacity could also be installed before network congestion (i.e. the bankability limit) would bind.

The objective of using dynamic ratings coupled with a post-contingent run-back scheme (Figs. 1, 3) increased energy output within a radial REZ. Model results in Section 4 indicate VRE capacity increases may be substantial with the relevant transfer capacity rising from 1500MW to 2375MW in line with windy conditions, which has a cooling effect on feeder ratings. The binding constraint then became how to re-secure the power system with the credible real-time loss of one feeder. FCAS quantities enabled then became a potentially important variable (Fig.3).

In a practical sense, achieving DLRs requires installation of real-time weather stations across lower spans of a radial REZ. The number of spans required may be significant to ensure the efficacy of ratings – which is not costless. The relevant real-time weather data then needs to be transmitted back to the network energy management system, with operating systems adjusted accordingly. Similar dynamic rating systems would also be required for substation equipment to ensure transmission line capacity is not stranded in the process (static ratings for substation equipment are similarly conservative based on elevated temperatures). But at this point, pre-contingent flows on a radial REZ may be lifted considerably. Adequacy of corresponding substation bus and bay ratings need to accommodate maximum feeder loadings prior to any run-back scheme, and, post the run-back scheme. Special protection schemes would also be required to eliminate the prospect of cascading failure of REZ infrastructure (including the potential loss of the double circuit) given the instantaneous loss of very large levels of output from a dynamically rated radial REZ feeder. This was highlighted in Fig.3 (RHS diagram).

Carrying greater reserves than the largest single contingency has historically been uneconomic. In a large thermal system, optimal spinning reserves equated to ‘n-1’ – a principle that can be traced at least as far back as Calabrese (1947).¹³ Yet ‘n-1’ spinning reserves is likely to be *underweight* FCAS in a world of high VRE. The combined forecast error associated with stochastic demand and VRE output now routinely exceeds ‘n-1’ in any event. More importantly, at the outset of this article the rising risks of site permitting and community acceptance was highlighted. If onshore radial REZs can be operated with dramatically higher flows and host more VRE capacity, policymakers and industry practitioners would be wise to pursue this outer operating envelope. Doing so will reduce costly transmission, planning and permitting risks and the number of impacted communities for a given level of VRE output. This tends to suggest ‘how’ rather than if DLR should be implemented.

6. References

- Abrell, J. and Kunz, F. (2015) ‘Integrating Intermittent Renewable Wind Generation - A Stochastic Multi-Market Electricity Model for the European Electricity Market’, *Networks and Spatial Economics*, 15(1), pp. 117–147.
- Alayo, H., Rider, M.J. and Contreras, J. (2017) ‘Economic externalities in transmission network expansion planning’, *Energy Economics*, 68, pp. 109–115.
- Ambrosius, M. *et al.* (2019) *The role of expectations for market design - on structural regulatory uncertainty in electricity*. Energy Policy Research Group, Working Paper No.1914. University of Cambridge.

¹³ The probability of losing two units simultaneously is typically remote in which case such non-credible contingencies are better managed through less costly interventions such as Under Frequency Load Shedding schemes, and in practice through excess capacity that would naturally exist in energy systems.

- Aravena, I. and Papavasiliou, A. (2017) 'Renewable Energy Integration in Zonal Markets', *IEEE Transactions on Power Systems*, 32(2), pp. 1334–1349.
- Averch, H. and Johnson, L. (1962) 'Behavior of the Firm under Regulatory Constraint', *American Economic Review*, 52(5), pp. 1052–1069.
- Bashir, S. (2020) *COGATI Reforms*. Nexa Advisory, Melbourne. Nexa Advisory, Melbourne.
- Bjørndal, M. and Jørnsten, K. (2001) 'Zonal Pricing in a Deregulated Electricity Market Author', *The Energy Journal*, 22(1), pp. 51–73.
- Bjørndal, M. and Jørnsten, K. (2008) 'Investment paradoxes in electricity networks', in A. Migdalas, P. Pardalos, and L. Pitsoulis, (eds) *Pareto Optimality, Game Theory and Equilibria*. Springer, pp. 593–608.
- Booth, R. (2000) *Warring Tribes: the Story of Power Development in Australia*. Perth: Bardak Group.
- Borenstein, B.S., Bushnell, J.B. and Wolak, F.A. (2002) 'Measuring Market Inefficiencies in California's Restructured Wholesale Electricity Market', *The American Economic Review*, 92(5), pp. 1376–1405.
- Brown, D.P., Zarnikau, J. and Woo, C.K. (2020) *Does locational marginal pricing impact generation investment location decisions? An analysis of Texas's wholesale electricity market*, *Journal of Regulatory Economics*. Springer US. Available at: <https://doi.org/10.1007/s11149-020-09413-0>.
- Calabrese, G. (1947) 'Generating Reserve Capacity Determined by the Probability Method', *Transactions of the American Institute of Electrical Engineers*, 66(1), pp. 1439–1450. Available at: <https://doi.org/10.1109/T-AIEE.1947.5059596>.
- Dodd, T. and Nelson, T. (2019) 'Trials and tribulations of market responses to climate change: Insight through the transformation of the Australian electricity market', *Australian Journal of Management*, 44(4), pp. 614–631.
- Dodd, T. and Nelson, T. (2022) 'Australian household adoption of solar photovoltaics: A comparative study of hardship and non-hardship customers', *Energy Policy*, 160. Available at: <https://doi.org/10.1016/j.enpol.2021.112674>.
- Eicke, A., Khanna, T. and Hirth, L. (2020) 'Locational Investment Signals: How to Steer the Siting of New Generation Capacity in Power Systems?', *The Energy Journal*, 41(1), pp. 281–304.
- Engelhorn, T. and Müsgens, F. (2021) 'Why is Germany's energy transition so expensive? Quantifying the costs of wind-energy decentralisation', *Resource and Energy Economics*, 65, p. 101241.
- Finon, D. (2008) 'Investment risk allocation in decentralised electricity markets. The need of long-term contracts and vertical integration', *OPEC Energy Review*, 32(2), pp. 150–183.
- Gohdes, N., Simshauser, P. and Wilson, C. (2022) 'Renewable entry costs, project finance and the role of revenue quality in Australia's National Electricity Market', *Energy Economics*, 114. Available at: <https://doi.org/10.1016/j.eneco.2022.106312>.
- Gohdes, N., Simshauser, P. and Wilson, C. (2023) 'Renewable investments, hybridised markets and the energy crisis: Optimising the CfD-merchant revenue mix', *Energy Economics*, 125, p. 106824. Available at: <https://doi.org/10.1016/j.eneco.2023.106824>.
- Gowdy, J. (2022) *Wild Texas Wind*. Regen Insight Paper, UK. Regen Insight Paper, UK.
- Green, R. (2007) 'Nodal pricing of electricity: How much does it cost to get it wrong?', *Journal of Regulatory Economics*, 31(2), pp. 125–149.
- Grimm, V. *et al.* (2016) 'On the long run effects of market splitting: Why more price zones might decrease welfare', *Energy Policy*, 94, pp. 453–467.
- Grubb, M. and Newbery, D. (2018) 'UK electricity market reform and the energy transition: Emerging lessons', *Energy Journal*, 39(6), pp. 1–25.

- Hadush, S., Buijs, P. and Belmans, R. (2011) 'Locational signals in electricity market design: Do they really matter?', *2011 8th International Conference on the European Energy Market, EEM 11*, (May), pp. 622–627.
- Hoecker, J.J. (1987) 'Used and Useful: Autopsy of a Ratemaking Policy', *Energy Law Journal*, 8(303), pp. 303–335.
- Holmberg, P. and Lazarczyk, E. (2015) 'Comparison of congestion management techniques: Nodal, zonal and discriminatory pricing', *Energy Journal*, 36(2), pp. 145–166.
- Jansen, M. *et al.* (2022) 'Policy choices and outcomes for offshore wind auctions globally', *Energy Policy*, 167. Available at: <https://doi.org/10.1016/j.enpol.2022.113000>.
- Joskow, P. and Tirole, J. (2007) 'Reliability and competitive electricity markets', *RAND Journal of Economics*, 38(1), pp. 60–84. Available at: <https://doi.org/10.1111/j.1756-2171.2007.tb00044.x>.
- Joskow, P.L. (1987) 'Productivity Growth and Technical Change in the Generation of Electricity', *The Energy Journal*, 8(1), pp. 17–38.
- Joskow, P.L. (2001) 'California's electricity crisis', *Oxford Review of Economic Policy*, 17(3), pp. 365–388. Available at: <https://doi.org/10.1093/oxrep/17.3.365>.
- Joskow, P.L. (2008) 'Capacity payments in imperfect electricity markets: Need and design', *Utilities Policy*, 16(3), pp. 159–170.
- Joskow, P.L. (2019) 'Challenges for wholesale electricity markets with intermittent renewable generation at scale: The US experience', *Oxford Review of Economic Policy*, 35(2), pp. 291–331. Available at: <https://doi.org/10.1093/oxrep/grz001>.
- Joskow, P.L. (2022) 'From hierarchies to markets and partially back again in electricity: Responding to decarbonization and security of supply goals', *Journal of Institutional Economics*, 18(2), pp. 313–329. Available at: <https://doi.org/10.1017/S1744137421000400>.
- Kann, S. (2009) 'Overcoming barriers to wind project finance in Australia', *Energy Policy*, 37(8), pp. 3139–3148. Available at: <https://doi.org/10.1016/j.enpol.2009.04.006>.
- Kellow, A. (1996) *Transforming Power – the Politics of Electricity Planning*. Cambridge: Cambridge University Press.
- Keppler, J.H., Quemin, S. and Saguan, M. (2022) 'Why the sustainable provision of low-carbon electricity needs hybrid markets', *Energy Policy*, 171. Available at: <https://doi.org/10.1016/j.enpol.2022.113273>.
- Leuthold, F., Weigt, H. and von Hirschhausen, C. (2008) 'Efficient pricing for European electricity networks - The theory of nodal pricing applied to feeding-in wind in Germany', *Utilities Policy*, 16(4), pp. 284–291.
- Mays, J., Morton, D.P. and O'Neill, R.P. (2019) 'Asymmetric risk and fuel neutrality in electricity capacity markets', *Nature Energy*, 4(11), pp. 948–956. Available at: <https://doi.org/10.1038/s41560-019-0476-1>.
- Mills, S.J. and Taylor, M. (1994) 'Project finance for renewable energy', *Renewable Energy*, 5(1–4), pp. 700–708. Available at: [https://doi.org/10.1016/0960-1481\(94\)90455-3](https://doi.org/10.1016/0960-1481(94)90455-3).
- Mountain, B. and Littlechild, S. (2010) 'Comparing electricity distribution network revenues and costs in New South Wales, Great Britain and Victoria', *Energy Policy*, 38(10), pp. 5770–5782. Available at: <https://doi.org/10.1016/j.enpol.2010.05.027>.
- Munoz, F.D. *et al.* (2017) 'Does risk aversion affect transmission and generation planning? A Western North America case study', *Energy Economics*, 64, pp. 213–225.
- Munoz, F.D., Watson, J.P. and Hobbs, B.F. (2015) 'Optimizing Your Options: Extracting the Full Economic Value of Transmission When Planning Under Uncertainty', *Electricity Journal*, 28(5), pp. 26–38.
- Nelson, T. *et al.* (2013) 'An analysis of Australia's large scale renewable energy target: Restoring market confidence', *Energy Policy*, 62, pp. 386–400.
- Nelson, T. (2015) 'Australian Climate Change Policy - Where To From Here?', *Economic Papers*, 34(4), pp. 257–272. Available at: <https://doi.org/10.1111/1759-3441.12114>.

- Nelson, T. (2018) 'The future of electricity generation in Australia: A case study of New South Wales', *Electricity Journal*, 31(1), pp. 42–50. Available at: <https://doi.org/10.1016/j.tej.2018.01.003>.
- Nelson, T., Nolan, T. and Gilmore, J. (2022) 'What's next for the Renewable Energy Target – resolving Australia's integration of energy and climate change policy?', *Australian Journal of Agricultural and Resource Economics*, 66(1), pp. 136–163. Available at: <https://doi.org/10.1111/1467-8489.12457>.
- Neuhoff, K. *et al.* (2013) 'Renewable electric energy integration: Quantifying the value of design of markets for international transmission capacity', *Energy Economics*, 40, pp. 760–772.
- Newbery, D. (2016) 'Missing money and missing markets: Reliability, capacity auctions and interconnectors', *Energy Policy*, 94(January), pp. 401–410.
- Newbery, D. (2021) 'Strengths and weaknesses of the British market model', in J.-M. Glanchant, P. Joskow, and M. Pollitt (eds) *Handbook on Electricity Markets*, pp. 156–181.
- Newbery, D. (2023) 'Efficient Renewable Electricity Support: Designing an Incentive-compatible Support Scheme', *The Energy Journal*, 44(3). Available at: <https://doi.org/10.5547/01956574.44.3.dnew>.
- Newbery, D.M. and Pollitt, M.G. (1997) 'The Restructuring and Privatisation of Britain's CEGB - was it worth it?', *The Journal of Industrial Economics*, 45(3), pp. 269–303.
- Oggioni, G., Murphy, F.H. and Smeers, Y. (2014) 'Evaluating the impacts of priority dispatch in the European electricity market', *Energy Economics*, 42, pp. 183–200.
- Oggioni, G. and Smeers, Y. (2012) 'Degrees of Coordination in Market Coupling and Counter-Trading', *The Energy Journal*, 33(3), pp. 39–90.
- Peltzman, S. (1976) *Toward a More General Theory of Regulation*. Working Paper No.133. Stanford, CA.
- Peter, J. and Wagner, J. (2021) 'Optimal allocation of variable renewable energy considering contributions to security of supply', *Energy Journal*, 42(1), pp. 229–260.
- Pierce, R.J. (1984) 'The Regulatory Treatment of Mistakes in Retrospect: Cancelled Plant and Excess Capacity', *University of Pennsylvania Law Review*, 132(497), pp. 497–560.
- Pollitt, M.G. (2004) 'Electricity reform in Chile: Lessons for developing countries', *Journal of Network Industries*, 5(3–4), pp. 221–262.
- Pollitt, M.G. (2023) *Locational Marginal Prices for Electricity in Europe? The Untold Story*. EPRG Working Paper 2318, Energy Policy Research Group, University of Cambridge. Available at: www.eprg.group.cam.ac.uk.
- Posner, R.A. (1974) 'Theories of Economic Regulation.', *Bell J Econ Manage Sci*, 5(2), pp. 335–358. Available at: <https://doi.org/10.2307/3003113>.
- Rai, A. and Nelson, T. (2020) 'Australia's National Electricity Market after Twenty Years', *Australian Economic Review*, 53(2), pp. 165–182.
- Rai, A. and Nelson, T. (2021) 'Financing costs and barriers to entry in Australia's electricity market', *Journal of Financial Economic Policy*, 13(6), pp. 730–754. Available at: <https://doi.org/10.1108/JFEP-03-2020-0047>.
- Roques, F. and Finon, D. (2017) 'Adapting electricity markets to decarbonisation and security of supply objectives: Toward a hybrid regime?', *Energy Policy*, 105, pp. 584–596. Available at: <https://doi.org/10.1016/j.enpol.2017.02.035>.
- Ruderer, D. and Zöttl, G. (2018) 'Transmission pricing and investment incentives', *Utilities Policy*, 55(September), pp. 14–30.
- Sauma, E.E. and Oren, S.S. (2006) 'Proactive planning and valuation of transmission investments in restructured electricity markets', *Journal of Regulatory Economics*, 30(3), pp. 261–290.

- Schittekatte, T. and Batlle, C. (2023) *Working Paper Series Power Crisis in the EU 3.0: Proposals to Complete Long-Term Markets*. MIT Center for Energy & Environmental Policy Research, CEEPR WP 2023-04. Available at: <https://cutt.ly/v3zl0ve>.
- Schweppe, F.C. *et al.* (1988) *Spot Pricing of Electricity*. US: Kluwer Academic Publishers.
- Simshauser, P. (2017) 'Monopoly regulation, discontinuity & stranded assets', *Energy Economics*, 66, pp. 384–398.
- Simshauser, P. (2021a) 'Lessons from Australia' s National Electricity Market 1998 – 2018 : strengths and weaknesses of the reform experience', in J. Glanchant, P. Joskow, and M. Pollitt (eds) *Handbook on Electricity Markets*. Cheltenham, UK: Edward Edgar Publishing, pp. 242–286.
- Simshauser, P. (2021b) 'Renewable Energy Zones in Australia' s National Electricity Market', *Energy Economics*, 101(July), p. 105446.
- Simshauser, P. (2022) 'Rooftop solar PV and the peak load problem in the NEM's Queensland region', *Energy Economics*, 109, p. 106002. Available at: <https://doi.org/10.1016/j.eneco.2022.106002>.
- Simshauser, P., Billimoria, F. and Rogers, C. (2022) 'Optimising VRE capacity in Renewable Energy Zones', *Energy Economics*, 113. Available at: <https://doi.org/10.1016/j.eneco.2022.106239>.
- Simshauser, P. and Gilmore, J. (2020) 'On entry cost dynamics in Australia's national electricity market', *Energy Journal*, 41(1), pp. 259–287.
- Simshauser, P. and Gilmore, J. (2022) 'Climate change policy discontinuity & Australia's 2016-2021 renewable investment supercycle', *Energy Policy*, 160(August 2021), p. 112648. Available at: <https://doi.org/10.1016/j.enpol.2021.112648>.
- Simshauser, P. and Tiernan, A. (2019) 'Climate change policy discontinuity and its effects on Australia's national electricity market', *Australian Journal of Public Administration*, 78(1), pp. 17–36.
- Steffen, B. (2018) 'The importance of project finance for renewable energy projects', *Energy Economics*, 69, pp. 280–294. Available at: <https://doi.org/10.1016/j.eneco.2017.11.006>.
- Stigler, G.J. (1971) 'The Theory of Economic Regulation', *Bell J Econ Manage Sci*, 2(1), pp. 3–21.
- Stigler, G.J. and Friedland, C. (1962) 'What Can Regulators Regulate? The Case of Electricity', *Journal of Law and Economics*, 5(Oct 1962), pp. 1–16.
- Tor, O.B., Guven, A.N. and Shahidehpour, M. (2008) 'Congestion-driven transmission planning considering the impact of generator expansion', *IEEE Transactions on Power Systems*, 23(2), pp. 781–789.
- Wagner, J. (2019) 'Grid investment and support schemes for renewable electricity generation', *Energy Journal*, 40(2), pp. 195–220.
- van der Weijde, A.H. and Hobbs, B.F. (2011) 'Locational-based coupling of electricity markets: Benefits from coordinating unit commitment and balancing markets', *Journal of Regulatory Economics*, 39(3), pp. 223–251.
- van der Weijde, A.H. and Hobbs, B.F. (2012) 'The economics of planning electricity transmission to accommodate renewables: Using two-stage optimisation to evaluate flexibility and the cost of disregarding uncertainty', *Energy Economics*, 34(6), pp. 2089–2101.
- Weiss, L.W. (1973) 'Antitrust in the Electric Power Industry', *Journal of Reprints for Antitrust Law and Economics*, 5(3 & 4), pp. 645–686.
- Wolak, F.A. (2022) 'Long-Term Resource Adequacy in Wholesale Electricity Markets with Significant Intermittent Renewables', *Environmental and Energy Policy and the Economy*, 3(1), pp. 155–220. Available at: <https://doi.org/10.3386/w29033>.